



Manuals.plus /

- › OMAC /
- › OMAC Smooth Roof Racks Cross Bars Instruction Manual for Honda CR-V 2017-2022

## OMAC Omega Crossbars Roof Racks (U026418)

# OMAC Smooth Roof Racks Cross Bars Instruction Manual

Model: Omega (U026418) for Honda CR-V 2017-2022

## PRODUCT OVERVIEW

---

The OMAC Smooth Roof Racks Cross Bars are designed to provide a secure and versatile cargo solution for your Honda CR-V (2017-2022 models). These aerodynamic cross bars are engineered for easy installation and feature an anti-theft design, ensuring both convenience and security for your belongings.

They are ideal for transporting a variety of gear, including kayaks, canoes, surfboards, skis, snowboards, and roof cargo boxes, making them a valuable accessory for adventure enthusiasts.



Image: OMAC Smooth Roof Racks Cross Bars, showing the product both individually and installed on a vehicle's roof.

## COMPATIBILITY

---

This product is specifically compatible with Honda CR-V models manufactured between 2017 and 2022. It is designed exclusively for vehicles with a **naked/smooth roof type**. Please verify your vehicle's roof type before installation to ensure proper fitment.

# FITS ONLY / KOMPATIBEL MIT / S'ADAPTE UNIQUEMENT



NAKED/SMOOTH  
NACKT/GLATT  
TOIT/LISSE



FACTORY INSTALLED ROOF RACKS  
WERKSEITIG INSTALLIERTER  
DACHGEPÄCKTRÄGER  
GALERIE DE TOIT INSTALLÉ EN USINE

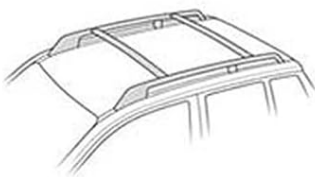

FLUSH RAILS  
BÜNDIGE SCHIENEN  
RAILS ENCASTRABLES

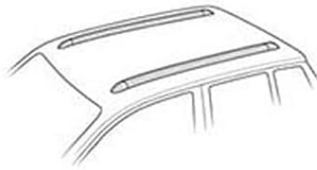

RAISED RAILS  
OFFENE DACHREILING  
RAILS SURÉLEVÉS

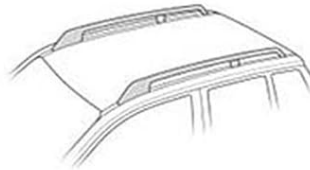

FIXED POINT  
FIXPUNKT  
POINT FIXE

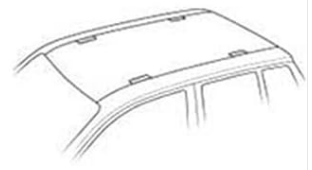

**ONAC**

Image: Compatibility diagram illustrating the required naked/smooth roof type for installation, and examples of incompatible roof types.

## WHAT'S IN THE BOX

Upon opening your package, please ensure all the following components are present:

- 2 Pieces of Roof Rack (Cross Bars)
- 2 Pieces of Lock
- 2 Pieces of Key
- 4 Pieces of Fixing Kit

# Package Includes | Paket Enthält | Le Paquet Inclut

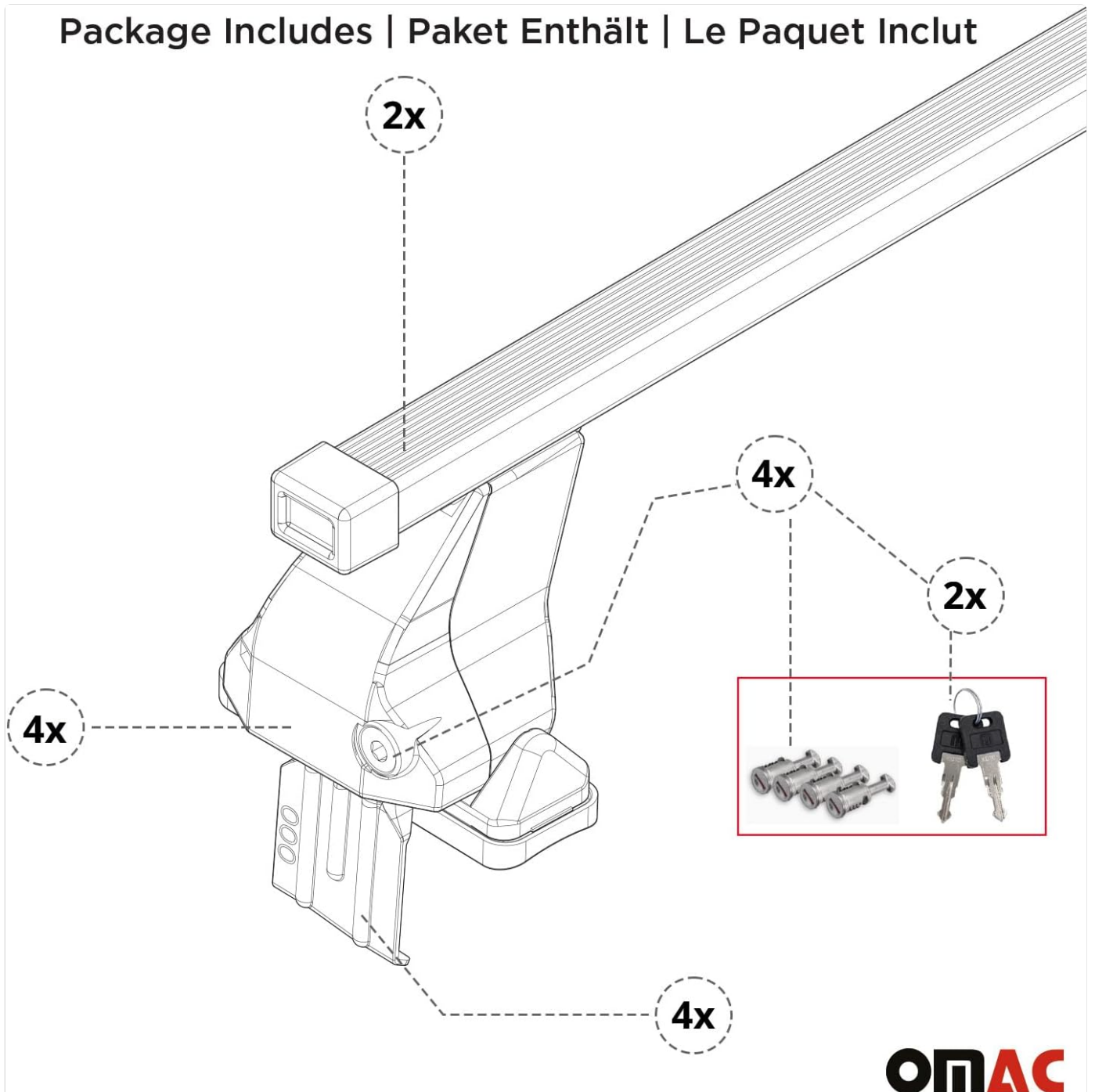

Image: Detailed diagram of package contents, including roof bars, locks, keys, and fixing kit components.

## Unboxing Video

Your browser does not support the video tag.

Video: An official OMAC video demonstrating the unboxing and initial assembly of the roof rack components.





## SPECIFICATIONS

---

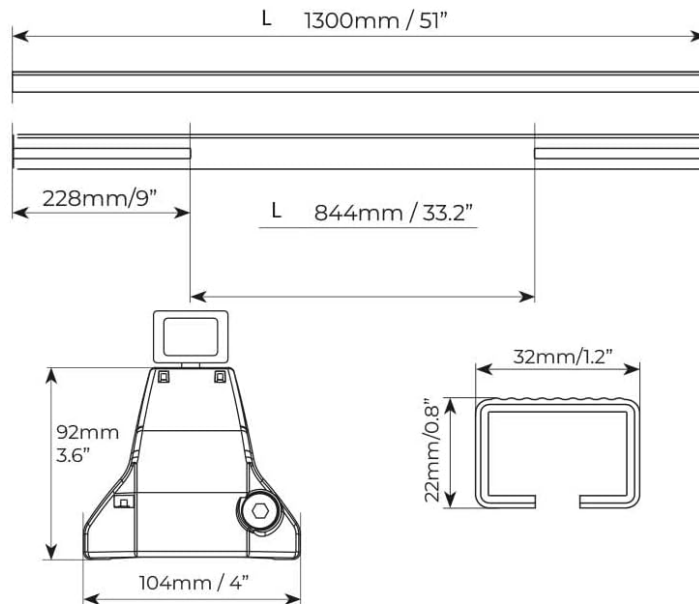
Feature	Detail
Color	Black
Material	High-quality Steel
Item Dimensions (L x W x H)	53 x 9 x 15 inches
Load Capacity	Up to 199.9 Pounds (approx. 90.7 kg)
Mounting Type	Roof Mount, Crossbar Mount
Special Features	Easy Installation, Lightweight, Durable, Multifunctional, Wind-Resistant, Anti-Theft Lock
Country of Origin	Italy

## PRODUCT INFORMATION | PRODUKTINFORMATION | INFORMATIONS SUR LE PRODUIT



 <ul style="list-style-type: none"> <li>•Product Weight</li> <li>•Produkt Gewicht</li> <li>•Poids du produit</li> </ul>	3,6kg / 8lbs	
<ul style="list-style-type: none"> <li>•Material</li> </ul>	Steel	
 <ul style="list-style-type: none"> <li>•Maximum load</li> <li>•Maximale Tragfähigkeit</li> <li>•Capacité de charge maximale</li> </ul>	max 50kg/110lbs	
 <ul style="list-style-type: none"> <li>•Anti-theft lock</li> <li>•Anti-Diebstahlschloss</li> <li>•Serrure anti-vol</li> </ul>	✓	
 <ul style="list-style-type: none"> <li>•Compatible vehicle roof types</li> <li>•Kompatible Fahrzeugdachtypen</li> <li>•Types de toits de véhicule compatibles</li> </ul>	Raised rails	x
	Flush rails	x
	Smooth roof	✓
	Fixed points	x

**ONAC**

Image: Technical specifications and dimensions of the roof rack components.

## INSTALLATION GUIDE

Follow these steps carefully for a secure installation of your OMAC Roof Racks. Refer to the included fixing kit manual for precise measurements for your specific Honda CR-V model.

### Step 1: Prepare the Cross Bars

1. Identify the front and rear cross bars. They may have different lengths or markings.
2. Consult your fixing kit manual to determine the correct measurement settings (D1 for front bar, D2 for rear bar) for your vehicle's model year.
3. Adjust the internal mechanism of each cross bar to match the specified measurements. This ensures the feet align correctly with your vehicle's roof.

## INSTALLATION DETAILS

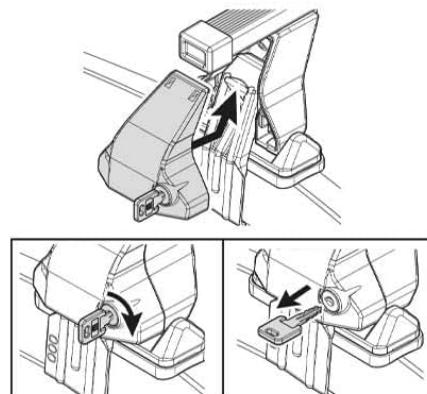
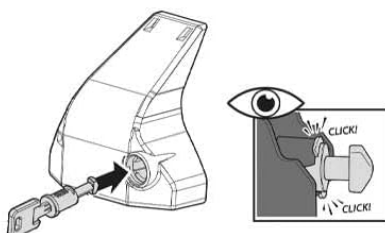
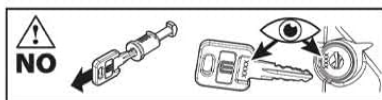
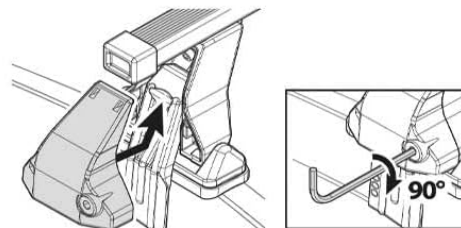
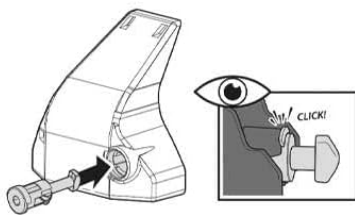
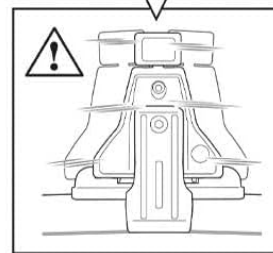
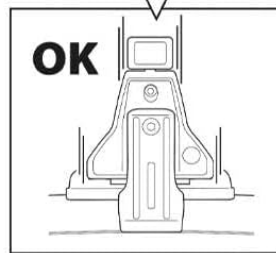
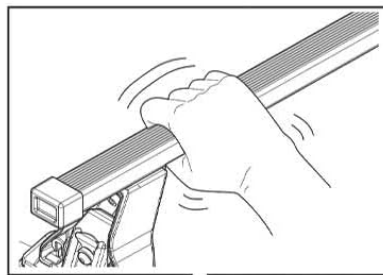

Image: Detailed installation steps, including adjusting the crossbar length according to the fixing kit manual.

## Step 2: Attach the Fixing Kit Components

1. Attach the rubber pads to the base of each roof rack foot. Ensure they are securely fitted to protect your vehicle's paintwork.
2. Insert the vehicle-specific clamps into the designated slots on the roof rack feet. These clamps are designed to grip your vehicle's smooth roof edge.
3. Secure the clamps using the provided screws and the hex key. Do not fully tighten at this stage.

Galvanized steel profiles covered with non-slip and scratch-proof PVC sheath.

Verzinkte Stahlprofile mit rutsch- und kratzfester PVC-Ummantelung.

Profils en acier galvanisé recouverts d'une gaine en PVC antidérapante et résistante aux rayures.



Vehicle specific  
Fahrzeugspezifisch  
Spécifique au véhicule

Steel clamps with scratch resistant plastic coating, rubber support pads.

Stahlklammern mit kratzfester Kunststoffbeschichtung, Gummiauflagen.

Pinces en acier avec revêtement en plastique résistant aux rayures, tampons de support en caoutchouc.

**ONAC**

Image: Close-up of the roof rack foot, highlighting the vehicle-specific clamp and its attachment point.

## Step 3: Position and Secure on Vehicle

1. Carefully place the assembled front and rear cross bars onto your vehicle's roof. Ensure the feet are correctly positioned over the designated mounting points (refer to your fixing kit manual for exact locations, typically indicated by A1 and A2 measurements).
2. Once positioned, begin tightening the screws on each foot using the hex key. Tighten gradually and evenly, alternating between sides and bars.
3. Initially tighten to 25-50% of full torque, then proceed to 75-100% to ensure even pressure and a secure fit. The

recommended torque is 6Nm (4.4 lbf-ft).

4. After tightening, install the anti-theft cover locks on each foot. Use the provided keys to lock them, preventing unauthorized removal.

## Installation Video

Your browser does not support the video tag.

Video: An official OMAC video demonstrating the fixed G point installation process for the roof racks on a vehicle.

## OPERATING AND USAGE

---

Your OMAC roof racks are designed for versatility and durability. They can be used to transport various items, including:

- Bike carriers
- Ski/snowboard carriers
- Roof cargo boxes
- Kayaks and canoes
- Surfboards

Always ensure that any attached accessories (e.g., bike racks, cargo boxes) are securely fastened to the cross bars according to their respective instruction manuals. Distribute weight evenly across the bars and adhere to the maximum load capacity.



Image: The roof racks in use, illustrating their versatility for carrying various sports equipment and cargo.

## SAFETY INFORMATION AND LOAD LIMITS

---

Adhering to safety guidelines is crucial when using roof racks. Failure to do so can result in damage to your vehicle, the roof racks, or personal injury.

- **Maximum Load Capacity:** Do not exceed the maximum load capacity of **199.9 pounds (approx. 90.7 kg)** for these roof racks. This includes the weight of the racks themselves, any attached accessories, and the cargo.
- **Vehicle Roof Load Limit:** Always consult your vehicle's owner's manual for its specific roof load limit. Never exceed the lower of the two limits (either the roof rack's limit or your vehicle's limit).
- **Weight Distribution:** Distribute the cargo weight as evenly as possible across the cross bars. Place heavier items closer to the center of the vehicle.
- **Secure Cargo:** Ensure all cargo is securely fastened to the roof racks using appropriate straps or tie-downs. Check tightness before and during your journey.
- **Speed Limits:** Reduce your speed, especially when carrying large or heavy loads, or in strong winds. Avoid sudden

braking or sharp turns.

- **Height Clearance:** Be aware of the increased height of your vehicle with the roof racks and cargo, especially when entering garages, car washes, or low-clearance areas.
- **Regular Checks:** Periodically check the tightness of all mounting bolts and the security of your cargo during long trips.

## Attention | Achtung | Attention



**OMAC**

Image: Important safety guidelines and warnings regarding load capacity, speed, and proper usage of the roof racks.

## MAINTENANCE

To ensure the longevity and optimal performance of your OMAC roof racks, follow these maintenance tips:

- **Regular Cleaning:** Clean the roof racks regularly with mild soap and water to remove dirt, road grime, and salt, which can cause corrosion. Rinse thoroughly and dry completely.
- **Inspect for Damage:** Periodically inspect all components for any signs of wear, cracks, bends, or corrosion. Pay close attention to the feet, clamps, and cross bars.
- **Check Tightness:** Before each use, and especially after the first few uses, check that all mounting bolts and screws are securely tightened. Re-tighten if necessary.
- **Lubrication:** If any moving parts (e.g., lock mechanisms) become stiff, apply a small amount of silicone-based lubricant.
- **Storage:** If you plan to remove the roof racks for an extended period, clean them thoroughly and store them in a dry, protected area away from direct sunlight and extreme temperatures.

## TROUBLESHOOTING

---

Here are some common issues and their potential solutions:

- **Issue:** Roof racks feel loose after installation.  
**Solution:** Re-check all mounting bolts and ensure they are tightened to the recommended torque (6Nm / 4.4 lbf·ft). Ensure the internal bar adjustments (D1/D2) are correct for your vehicle model as per the fixing kit manual.
- **Issue:** Excessive wind noise or whistling.  
**Solution:** Ensure the cross bars are installed correctly and are not twisted. Check that all end caps are securely in place. Sometimes, repositioning cargo slightly can reduce noise.
- **Issue:** Difficulty locking the anti-theft covers.  
**Solution:** Ensure the cover is properly aligned with the lock mechanism. The internal screw must be fully tightened before the cover can be locked. Do not force the key.
- **Issue:** Scratches on vehicle roof after installation.  
**Solution:** This usually indicates that the protective rubber pads were not correctly installed or have shifted. Ensure pads are clean and properly seated before placing the racks on the roof. Always clean the roof surface thoroughly before installation.

## WARRANTY AND SUPPORT

---

OMAC products are manufactured with high-quality standards. For any warranty claims, technical support, or inquiries regarding your roof racks, please contact OMAC customer service directly. Keep your purchase receipt as proof of purchase.

You can find more information and contact details on the official OMAC website or through your original point of purchase.

For additional protection, consider the available protection plans offered at the time of purchase:

- 2-Year Protection Plan
- Complete Protect: One plan covers all eligible past and future purchases