

Alpicool CX50

Alpicool CX50 50L Portable Car Refrigerator and Freezer User Manual

Model: CX50

[Introduction](#) [Safety Instructions](#) [Package Contents](#) [Product Overview](#) [Setup](#) [Operation](#)
[Maintenance](#) [Troubleshooting](#) [Specifications](#) [Warranty & Support](#)

1. INTRODUCTION

This manual provides essential information for the safe and efficient operation of your Alpicool CX50 50L Portable Car Refrigerator and Freezer. Please read these instructions carefully before use and retain them for future reference. This appliance is designed for cooling and freezing items in various environments, including vehicles, homes, and during outdoor activities like camping.

2. SAFETY INSTRUCTIONS

WARNING: Failure to follow these safety instructions may result in fire, electric shock, or injury.

- Ensure proper ventilation around the appliance. Do not block ventilation openings.
- Do not use electrical appliances inside the refrigerator unless they are of the type recommended by the manufacturer.
- Do not store explosive substances such as aerosol cans with a flammable propellant in this appliance.
- The appliance must be connected to a power supply that matches the voltage specified on the rating label.
- Do not immerse the appliance in water or expose it to rain.
- Keep the appliance away from heat sources and direct sunlight.
- Children should be supervised to ensure they do not play with the appliance.
- Disconnect the power supply before cleaning or performing maintenance.

3. PACKAGE CONTENTS

Verify that all items are present in the package:

- 1 x Alpicool CX50 Car Refrigerator
- 1 x 12/24V DC Power Cord (2.5 meters)
- 1 x 100-240V AC Cable with Adapter
- 1 x User Manual
- 1 x Telescopic Handle (pre-installed or to be attached)
- 2 x Durable Wheels (pre-installed or to be attached)



Image: Contents of the Alpicool CX50 package, including the refrigerator, DC power cord, AC cable with adapter, and user manual.

4. PRODUCT OVERVIEW

The Alpicool CX50 is a portable compressor refrigerator and freezer designed for versatile use. It features a robust construction, efficient cooling, and user-friendly controls.

Key Features:

- **Fast Cooling:** Utilizes advanced refrigeration technology to reach temperatures as low as -20°C quickly.
- **Large Capacity:** 50-liter capacity suitable for various food and beverage storage.
- **Battery Protection:** Three-level battery protection system prevents vehicle battery drain.
- **Dual Power Supply:** Operates on both DC (12V/24V) and AC (100-240V) power.
- **Portability:** Equipped with durable wheels and a telescopic handle for easy transport.
- **Anti-Shock Design:** Engineered to function reliably on uneven terrain and inclines up to 40 degrees.

FACILE À DÉPLACER

Avec deux roues durables et une poignée télescopique, cette glacière peut être facilement déplacée partout.



Poignée télescopique



Roue durable

Image: The Alpicool CX50 refrigerator showcasing its durable wheels and extendable telescopic handle for easy movement. The handle extends to a maximum total height of 87 cm.

Durable Telescoping Handle

MAX total height:



Image: A sequence demonstrating the extension of the durable telescoping handle on the Alpicool CX50, showing its maximum total height of 99.5 cm / 35.5 inches.

CONCEPTION ANTICHOC

La conception anti-vibration protège bien le refroidisseur. Il peut également fonctionner normalement sur des routes cahoteuses et même sur des pentes avec un angle inférieur à 40°.



Image: Illustration of the Alpicool CX50's anti-vibration design, demonstrating its ability to operate on inclines up to 40 degrees, suitable for rough roads.

5. SETUP

5.1 Unpacking

Carefully remove the refrigerator from its packaging. Inspect the unit for any damage that may have occurred during transit. Report any damage to your retailer immediately.

5.2 Placement

Place the refrigerator on a stable, level surface. Ensure there is adequate ventilation around the unit, leaving at least 10 cm of space on all sides for proper airflow. Avoid placing the unit in direct sunlight or near heat sources.

5.3 Power Connection

The Alpicool CX50 can be powered by either DC (12V/24V) or AC (100-240V) power.

- **DC Connection (Car/Vehicle):** Connect the 12/24V DC power cord to the refrigerator's DC input port and then to your vehicle's cigarette lighter socket.

- **AC Connection (Home/Dorm/Camping):** Connect the AC cable to the adapter, then plug the adapter into the refrigerator's AC input port. Finally, plug the AC cable into a standard wall outlet.



Notre réfrigérateur portable fournit deux types d'adaptateur d'alimentation.





Cordon secteur EU avec adaptateur





Connecteur 12/24 V CC

Image: The Alpicool CX50 portable refrigerator showing its two types of power adapters: an EU AC power cord with adapter for indoor use and a 12/24V DC connector for vehicle use.

DC USE
12V/24V

RV Travel

AC USE
100-240V

Home

Connect with
power station

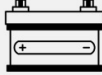
Camping

Different Power connection



Image: Visual representation of the different power connection options for the Alpicool CX50, including DC (12V/24V) for RV travel, AC (100-240V) for home use, and connection with a power station for camping.

5.4 Initial Use

After connecting to power, the unit will turn on. Allow the refrigerator to cool down for at least 30 minutes before placing items inside. This ensures the internal temperature stabilizes at your desired setting.

6. OPERATING INSTRUCTIONS

6.1 Control Panel

The control panel typically includes a display, temperature adjustment buttons (+/-), and a power button. Refer to the specific layout on your unit for exact button functions.

6.2 Temperature Setting

Press the '+' or '-' buttons to adjust the desired temperature. The display will show the current internal temperature and then briefly flash the set temperature. The unit will automatically adjust to reach and maintain the set temperature.

REFROIDISSEMENT ET CONGÉLATION EFFICACES

Produit une expérience de refroidissement et de congélation impressionnante.

De 25 °C à 0 °C en seulement 15 minutes !

Power: Puissance : 60W

Rapid Cooling: Refroidissement rapide

Energy Saving: Économie d'énergie

Silent Operation: Fonctionnement silencieux

BCA018LAVV
120V
USE ONLY WITH I.G. CONTROLLER

The advertisement features a blue and white winter-themed background with snowflakes. At the bottom, a black Alpicool CX50 refrigerator is shown sitting on a snowy surface. The refrigerator's label is clearly visible, showing the model number and technical specifications.

Image: Demonstrates the efficient cooling and freezing capabilities of the Alpicool CX50, highlighting its ability to cool from 25°C to 0°C in just 15 minutes, with features like 60W power, rapid cooling, energy saving, and silent operation.

6.3 Battery Protection Mode

The refrigerator features a three-level battery protection system (Low, Medium, High) to prevent your vehicle's battery from draining completely. You can select the desired mode based on your vehicle's battery condition and usage.

- **Low Mode:** Provides the longest operating time but may risk draining a weaker battery.
- **Medium Mode:** A balanced setting for most situations.
- **High Mode:** Offers maximum battery protection, cutting off power at a higher voltage.

To change the battery protection mode, consult your unit's specific instructions, usually involving holding a button or navigating a menu on the control panel.

Voltage Reference for Battery Protection Modes



Mode	DC 12V		DC 24V	
	Cut Out	Cut In	Cut Out	Cut In
Low Mode	8.5V	10.9V	21.3V	22.7V
Medium Mode	10.1V	11.1V	22.3V	23.7V
High Mode	11.1V	12.4V	24.3V	25.7V

Note: This car fridge does not contain batteries and needs to be connected to a power source for use.



3 LEVEL BATTERY PROTECTION MODE

Aims to protect your car battery from running out when its voltage is low

Voltage Reference					
Mode	Input	DC 12V		DC 24V	
		Cut Out	Cut In	Cut Out	Cut In
 Low Mode		8,5V	10,9V	21,3V	22,7V
 Medium Mode		10,1V	11,1V	22,3V	23,7V
 High Mode		11,1V	12,4V	24,3V	25,7V

Note: This car fridge does not contain batteries and need to be connected to power source for use

Image: Diagram illustrating the three-level battery protection mode (Low, Medium, High) with corresponding cut-out and cut-in voltages for both DC 12V and DC 24V inputs, designed to protect your car battery.

7. MAINTENANCE

7.1 Cleaning

- Always disconnect the power supply before cleaning.
- Clean the interior and exterior surfaces with a damp cloth and a mild detergent.
- Do not use abrasive cleaners or harsh chemicals.
- Ensure the ventilation openings are clear of dust and debris.

7.2 Defrosting

Frost may accumulate on the interior cooling surfaces, especially in humid conditions. To defrost:

- Turn off the appliance and disconnect it from the power supply.

- Remove all contents.
- Leave the lid open to allow the frost to melt naturally.
- Wipe away melted water with a clean cloth. Do not use sharp objects to remove frost.

7.3 Storage

When storing the refrigerator for an extended period:

- Ensure the unit is clean and dry.
- Leave the lid slightly ajar to prevent odors and mold growth.
- Store in a dry, well-ventilated area, away from direct sunlight and extreme temperatures.

8. TROUBLESHOOTING

If you encounter issues with your Alpicool CX50, refer to the following common problems and solutions:

Problem	Possible Cause	Solution
Appliance does not turn on	No power supply; Faulty power cable; Low battery voltage (in DC mode)	Check power connection; Replace cable if damaged; Adjust battery protection mode or charge vehicle battery.
Insufficient cooling	Poor ventilation; Too high ambient temperature; Lid not closed properly; Excessive items inside; Incorrect temperature setting	Ensure proper airflow; Move to a cooler location; Close lid securely; Reduce contents; Adjust temperature setting lower.
Unusual noise	Appliance not level; Items inside vibrating; Fan obstruction	Place on a level surface; Secure items inside; Clear any obstructions from the fan.
Error code on display	Specific internal fault	Refer to the full user manual for specific error code meanings and solutions, or contact customer support.

9. SPECIFICATIONS

Feature	Detail
Brand	Alpicool
Model Name	CX50
Capacity	50 Liters (47 Liters usable volume)
Dimensions (L x W x H)	63.1 cm x 38 cm x 87 cm (approx. 38P x 63.1l x 87H centimeters)
Item Weight	13.4 Kilograms
Color	Grey
Material	Stainless Steel, Acrylonitrile Butadiene Styrene (ABS)
Power Input	DC 12V/24V, AC 100-240V

Feature	Detail
Special Feature	Water Dispenser (Note: This may refer to a drain plug for melted ice/water)
Recommended Uses	Camping, Picnic
Insulation Type	Polyurethane Foam
Noise Level	45 dB
Energy Efficiency Class	D
Annual Energy Consumption	60 kWh/annum
Climate Class	Tropical

CAPACITÉ : 50 L POIDS : 13,4 kg

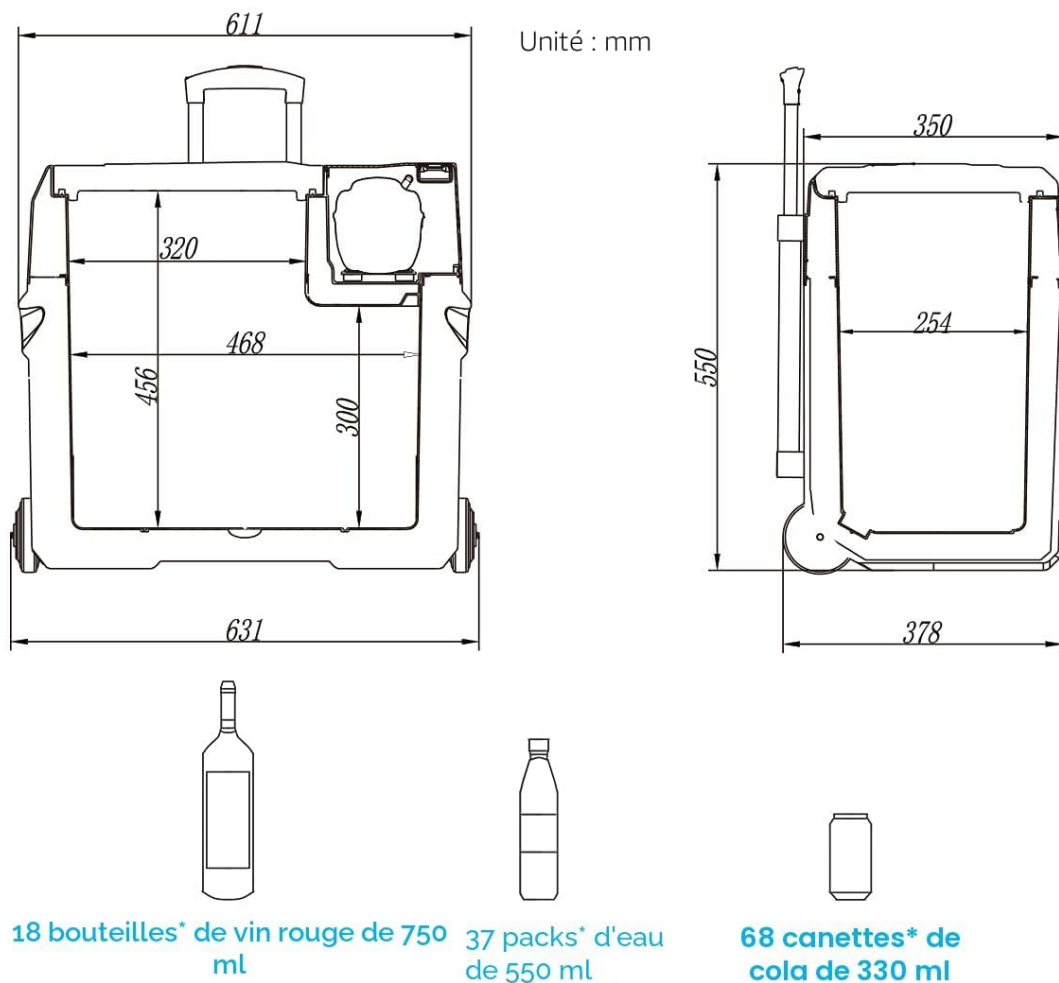

Image: Technical drawing showing the dimensions of the Alpicool CX50 refrigerator in millimeters, along with visual representations of its capacity for 18 bottles of 750ml wine, 37 bottles of 550ml water, or 68 cans of 330ml cola.

Product Information Sheet

COMMISSION DELEGATED REGULATION (EU) 2019/2016 with regard to energy labelling of refrigerating appliances

Supplier's name or trade mark: Alpicool

Supplier's address: Alpicool GmbH, c/o ZHU Consulting GmbH, Am Seestern 8, 40547 Düsseldorf#Germany					
Model identifier: CX50					
Type of refrigerating appliance:					
Low-noise appliance:	No	Design type:	freestanding		
Wine storage appliance:	No	Other refrigerating appliance:	Yes		
General product parameters:					
Parameter	Value	Parameter	Value		
Overall dimensions (millimetre)	Height	550	Total volume (dm³ or l)	47	
	Width	610			
	Depth	378			
EEI	78	Energy efficiency class	D		
Airborne acoustical noise emissions (dB(A) re 1 pW)	45	Airborne acoustical noise emission class	D		
Annual energy consumption (kWh/a)	60	Climate class:	temperate, subtropical, tropical		
Minimum ambient temperature (°C), for which the refrigerating appliance is suitable	16	Maximum ambient temperature (°C), for which the refrigerating appliance is suitable	27		
Winter setting	No				
Compartment Parameters:					
Compartment parameters and values					
Compartment type	Compartment Volume (dm³ or l)	Recommended temperature setting for optimised food storage (°C) These settings shall not contradict the storage conditions set out in Annex IV, Table 3	Freezing capacity (kg/24h)	Defrosting type (auto-defrost=A, manual defrost=M)	
Pantry	Yes	47,0	17	-	M

Page 1 / 2

Wine storage	No	-	-	-	-
Cellar	No	-	-	-	-
Fresh food	No	-	-	-	-
Chill	No	-	-	-	-
0-star or ice-making	No	-	-	-	-
1-star	No	-	-	-	-
2-star	No	-	-	-	-
3-star	No	-	-	-	-
4-star	No	-	-	-	-
2-star section	No	-	-	-	-
Variable temperature compartment	-	-	-	-	-

Light source parameters:					
Type of light source	-				
Energy efficiency class	-				
Minimum duration of the guarantee offered by the manufacturer: 3 months					
Additional information:					
Weblink to the supplier's website, where the information in point 4 of Annex II of Commission Regulation (EU) 2019/2019 is found: www.alpicool.com					

Model placed on the Union market from 11/02/2025



EPREL registration number: 2362397 <https://eprel.ec.europa.eu/qr/2362397>

Supplier: ERP EUROPE LTD (Manufacturer) Website:

Customer care service:

Name: Alpicool GmbH Website:

Email: bill@alpicool.com Phone: +49 170 8075723

Address:
c/o ZHU Consulting GmbH, Am Seestern 8, 40547 Düsseldorf#Germany

Image: The energy label for the Alpicool CX50, indicating an energy efficiency class D, 60 kWh/annum consumption, 47L capacity, and 45dB noise level. For more details, scan the QR code or visit eprel.ec.europa.eu/qr/2362397.

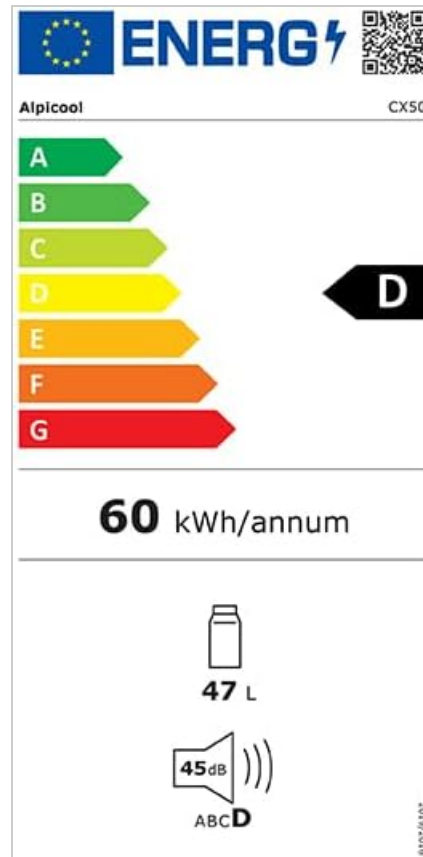

Image: A product information sheet detailing compliance with COMMISSION DELEGATED REGULATION (EU) 2019/2016, including supplier name, model identifier, type of refrigerating appliance, general product parameters, and additional information.

10. WARRANTY & SUPPORT

10.1 Warranty Information

The Alpicool CX50 comes with a **1-year warranty** from the date of purchase. This warranty covers manufacturing defects and malfunctions under normal use. Please retain your proof of purchase for warranty claims.

10.2 Customer Support

For technical assistance, troubleshooting beyond this manual, or warranty inquiries, please contact Alpicool customer support. Contact details can typically be found on the manufacturer's official website or through your retailer.

Manufacturer: Alpicool

Country of Origin: China

