

## Blackburn BL475CLRC

# Blackburn Click USB Light Instruction Manual

Model: BL475CLRC

## INTRODUCTION

---

The Blackburn Click USB Light is a compact and versatile bicycle light designed to enhance your visibility and safety. This manual provides essential information for the proper setup, operation, and maintenance of your light.

### Key Features:

- **ANSI FL-1 Standard Compliant:** Tested to provide consistent performance measurements for brightness, run time, and water resistance.
- **IP-65 Water and Dust Resistant:** Fully protected against dust and grit, and resistant to strong jets of water from all directions.
- **USB Rechargeable:** Conveniently recharges via any standard USB port, eliminating the need for disposable batteries.
- **Versatile Mounting:** Features an integrated clip and a silicone mounting strap for flexible placement on your bicycle or gear.

## SETUP

---

### Mounting the Light

The Blackburn Click USB Light offers flexible mounting options. Use the integrated clip to attach it to bags or clothing, or utilize the included silicone strap for secure attachment to your bicycle's handlebars, seat post, or frame.

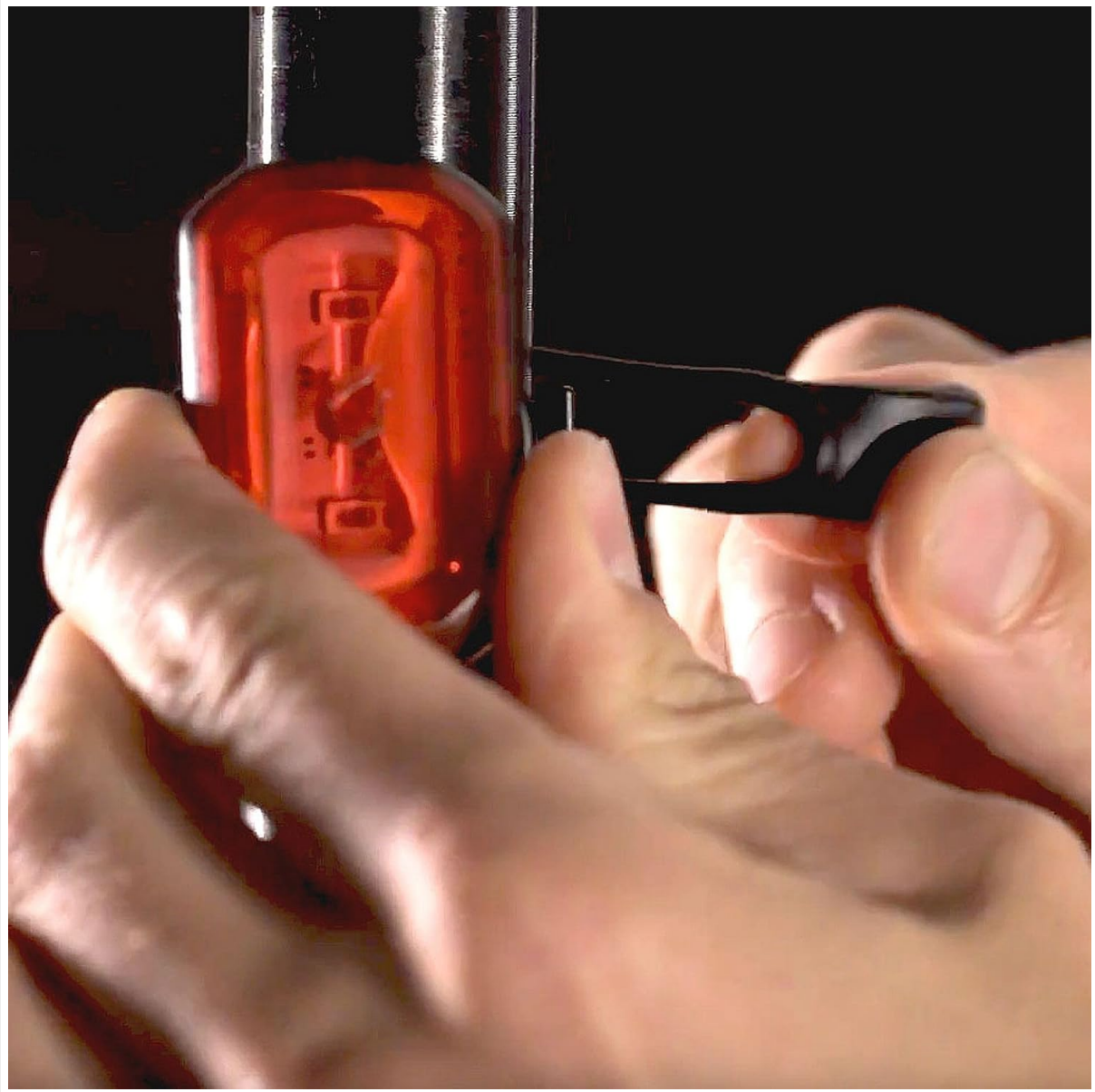

Image: Hands demonstrating how to attach the light using the silicone strap to a bike post.



Image: The Blackburn Click USB Light mounted on a bicycle seat post, showing its rear-facing position.

### **Charging the Battery**

Before first use, fully charge the light. To charge, simply plug the integrated USB connector directly into any standard USB port (e.g., on a computer, wall adapter, or power bank). A red indicator light will show that the device is charging, and it will turn off or change color when fully charged.



Image: The Blackburn Click USB Light connected to a laptop via its integrated USB cable for charging.

Video: This video demonstrates the features of the Blackburn Click USB Light, including its mounting options, charging process, and visibility.

## OPERATING INSTRUCTIONS

---

### Power On/Off and Mode Selection

The Blackburn Click USB Light is operated using a single button located on the light's body.

- **To Turn On:** Press the button once.
- **To Cycle Modes:** Press the button repeatedly to switch between the available light modes (e.g., continuous, flashing). This model features 2 distinct settings.
- **To Turn Off:** Press and hold the button for approximately 1-2 seconds.

## MAINTENANCE

---

### Cleaning

To maintain optimal performance and appearance, regularly clean your light. Wipe the exterior with a soft, damp cloth. Avoid using abrasive cleaners, solvents, or harsh chemicals, as these can damage the light's casing or lens.

## Battery Care

For best battery longevity, avoid completely draining the battery before recharging. Recharge the light regularly, especially if it has not been used for an extended period. Store the light in a cool, dry place when not in use.

## TROUBLESHOOTING

---

### Light Not Turning On

- Ensure the battery is sufficiently charged. Connect the light to a USB power source and check if the charging indicator activates.
- Press and hold the power button for a few seconds to confirm it is not in a standby or locked mode.

### Light Not Charging

- Verify that the USB connection is secure and fully inserted into both the light and the power source.
- Try using a different USB port or a different charging adapter to rule out issues with the power source.
- Inspect the charging port on the light for any debris or damage that might obstruct the connection.

## SPECIFICATIONS

---

### Product Details:

Feature	Detail
Brand	Blackburn
Model Number	BL475CLRC (7074412)
Color	Black
Material	Plastic
Power Source	USB Charging
Water Resistance Level	IP65 (Water Resistant)
Item Weight	22 Grams
Mounting Type	Seat Mount (also clip-on)
Number of Settings	2
Light Output Maximum	20 Lumens
Auto Part Position	Rear
UPC	768686731105

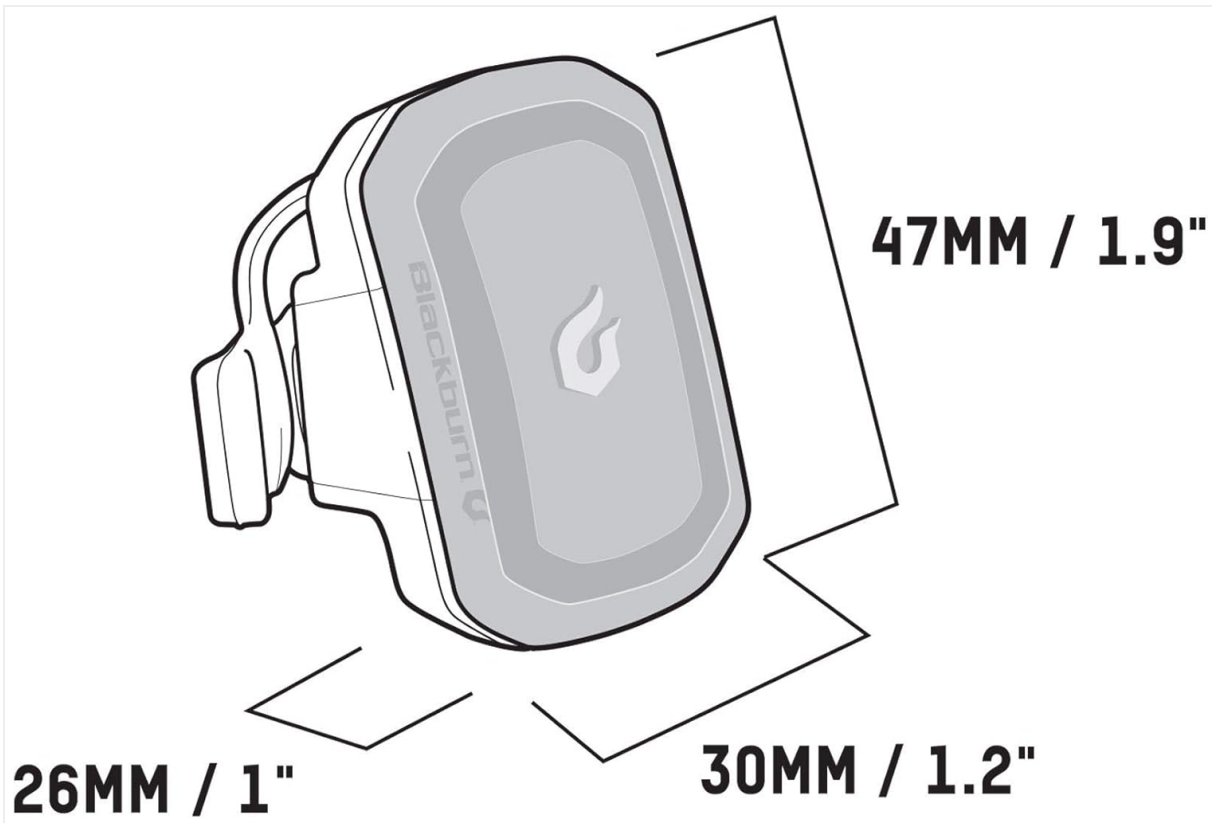









Image: Diagram showing the dimensions of the Blackburn Click USB Light: 47mm (1.9") length, 30mm (1.2") width, and 26mm (1") depth.

### BLACKBURN LUMEN CHART

REAR LIGHTS		HIGH	LOW	FLASH	STROBE	GROUP RIDE
	DAYBLAZER 125 #7097042 / \$55	LUMENS 100	65	125	65	3
		RUN TIME 1.6h	3h	3h	6h	20-25h
	DAYBLAZER 65 #7097041 / \$33	LUMENS 50		65	35	3
		RUN TIME 1.5h		3h	6h	20-25h
	2'FER-XL #7085185 / \$50	LUMENS 40		40		
		RUN TIME 4h		6h		
	2'FER #7064519 / \$27	LUMENS 20		20		
		RUN TIME 1.5h		5h		
	LOCAL 15 #7053779 / \$22	LUMENS 15		15	15	
		RUN TIME 48h		95h	108h	
	CLICK USB #7074412 / \$22	LUMENS 20			20	
		RUN TIME 1.5h			3h	
	CLICK #7085175 / \$16	LUMENS 4		4		
		RUN TIME 70h		130h		

6/2020

Image: A lumen chart comparing various Blackburn rear lights, showing the Click USB model with 20 lumens and a run time of 1.5 hours (continuous) or 3 hours (strobe).

## WARRANTY AND SUPPORT

---

### Warranty Information

The Blackburn Click USB Light is covered by a **2-Year Warranty Provision** for battery or electrically powered products, product components, and accessories. Please retain your proof of purchase for warranty claims.

### Customer Support

For further assistance, technical support, or to inquire about warranty services, please visit the official Blackburn website or contact their customer service department. Contact information can typically be found on the product packaging or the manufacturer's website.